

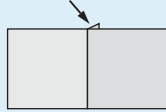

### About our Patterns

We recommend that you read all of the instructions before starting a project and that you cut and sew one block before cutting all of your fabric.

Using a rotary cutter, mat and an acrylic ruler, cut the shape to the size indicated in the cutting list.



**Pressing tabs** indicate the direction to press the seam allowances.

Our patterns list **finished** block sizes, which are typically 1/2" smaller than unfinished block sizes because they do not include seam allowances.

### Basic Quilting Supplies

- Rotary cutter and mat
- Acrylic ruler: Many shapes and sizes are available; a good one to start with is 6" x 24" with 1/4" and 1/8" markings
- Scissors: A separate pair for paper and fabric
- Sewing machine
- 1/4" foot
- Walking foot
- Darning foot
- Pins
- Ironing board & iron
- Marking pencils/markers/etc.
- Needles
- Thimble
- Safety pins
- Template plastic
- Thread

### trimming template

To ensure accurate piecing of triangular patches, you may want to trim the points on patches with 45° angles. Make a template from the full-size trimming template pattern shown here. Align the edges of the trimming template with the patch and trim each point. You may only need to align one of the trimmed sides with the adjacent patch before sewing.

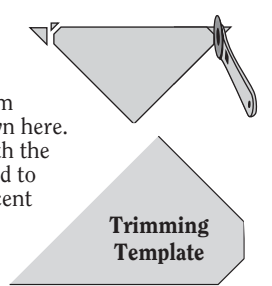

The way you mark, cut and sew varies significantly from machine piecing to hand piecing, so please refer to the appropriate section before starting a project.

### preparing your fabric

We recommend that you pre-wash your fabrics. A shrinkage factor is included in our yardage computations.

### machine piecing

It is important to cut accurately and to sew exact 1/4" seams.

#### Templates

Trace the patterns on template plastic and cut out accurately.

#### Planning

Measure, mark and cut the binding and border strips before cutting patches from the same fabric. Cut larger patches before smaller ones. For best use of the fabric, arrange patches with cutting lines close or touching.

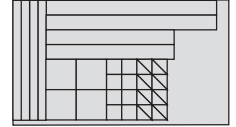

One or more straight sides of the patch should follow the lengthwise (parallel to the selvages) or crosswise (perpendicular to the selvages) **grain of fabric**, especially the sides that will be on the outside edges of the quilt block. We indicate lengthwise or crosswise grain with an arrow on the pattern piece.

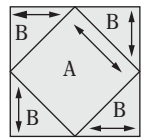

#### Cutting

To find the grainline of your fabric for rotary cutting, hold the fabric with selvages parallel in front of you. Keeping the selvages together, slide the edge closest to you to one side or the other until the fabric hangs straight, without wrinkles or folds. Then lay the fabric down on your cutting mat and cut perpendicular to the fold line. Use this cut edge as your straight-of-grain line.

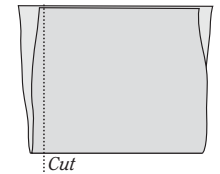

Many patches can be cut from strips of fabric by rotary cutting. First, cut a strip of fabric the width needed. Then, cross-cut strips into patches.

To cut from a template, place the template face down on the wrong side of the fabric and trace with a sharp pencil. Reverse (r) templates should be placed face up on the wrong side of the fabric before tracing.

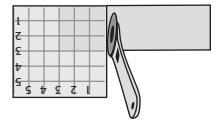

#### Piecing

Align the cut edges of fabric with the edge of the presser foot if it is 1/4" wide. If not, place masking tape on the throat plate of your machine 1/4" away from the needle to guide you. Sew all the way to the cut edge.

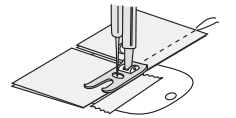

### hand piecing

#### Templates and Cutting Patches

Mark the seam lines rather than cutting lines when hand piecing. Cut out patches approximately 1/4" beyond the marked seam lines.

To make a template for hand piecing, trace the seam (dashed) line of a full-size template pattern on template plastic. To convert rotary cutting diagrams to hand-piecing templates, first draw the shape to scale, then subtract 1/4" from every side. Trace the full-size templates on the wrong side of your fabric using a sharp pencil, leaving at least 1/2" between each traced line.

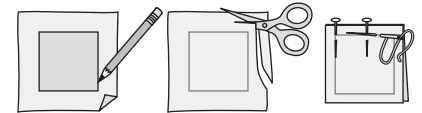

#### Piecing

Put patches right sides together matching seam lines. Sew the seam through the marked lines with a short running stitch using a single thread. Begin and end stitching at the seam line (not the edge of the fabric) with 2 or 3 backstitches to secure the seam.

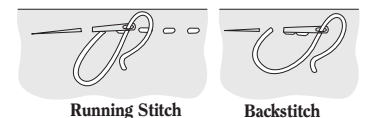

Running Stitch

Backstitch

## foundation piecing

Make paper copies of each foundation. Sew patches in the numerical order printed on the pattern. Center fabric under #1, extending beyond the seam allowances, wrong side of the fabric to the unprinted side of the paper and pin in place from the paper side.

Turn fabric side up. Using a patch of fabric sufficient to cover #2 and its seam allowances, position the #2 patch right sides together on patch #1 as shown so that the fabric's edge extends at least  $\frac{1}{4}$ " into the #2 area. Pin in place. Set a very short stitch length on your sewing machine (18–20 stitches per inch or 1.5 mm). Turn the assembly paper side up. Stitch through the paper and the fabric layers along the printed seam line, beginning and ending  $\frac{1}{4}$ " beyond the ends of the line.

Turn assembly to the fabric side. Trim the seam allowances to approximately  $\frac{1}{4}$ ". Press the fabric open to cover #2 and seam allowances.

Repeat this process to complete the blocks or sections, allowing at least  $\frac{1}{4}$ " beyond the edge of the paper.

Use a rotary cutter and ruler to trim  $\frac{1}{4}$ " outside the seam line of the foundation, creating a seam allowance. If necessary, join sections by matching points and sewing with  $\frac{1}{4}$ " seam. Once all the seams around a foundation section have been sewn, remove the paper foundations.

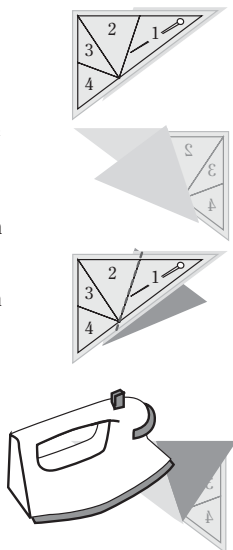

## applique

No turn-under allowances are given on applique patterns.

Using a light table if needed, position background fabric over the applique placement diagram. Lightly mark the major shapes with pencil or chalk. Optionally, finger crease the fabric in half lengthwise, crosswise and diagonally to form guidelines for placement of the patches.

Use a stabilizer on the back to support machine stitching that is dense (like satin stitching) and to keep the fabric from tunneling. Choose a stabilizer that matches the weight of the fabric. After the applique is complete, gently remove the stabilizer.

### Turned-Edge Applique

It is helpful to have as many bias edges as possible on the perimeter of your applique patches. Trace and cut on the seam line of the pattern to make a template. Place the template face up on the right side of the fabric (face down on the right side for a reverse patch) and lightly draw around it. Cut out each patch about  $\frac{3}{16}$ " outside the marked line.

On inward curves, clip the  $\frac{3}{16}$ " allowances almost to the marked seam line. Turn under the allowance and finger press.

Pin or baste applique patches on the background fabric. To applique by hand, use a blind stitch and a thread color that matches the patch. To applique by machine, use a small zigzag or blind hem stitch and a matching or invisible thread.

If the background fabric shows through the appliqued patch, carefully cut away the background fabric to within  $\frac{3}{16}$ " of the applique patch or use 2 layers of applique fabric.

### Fusible Applique

Raw-edge applique using paper-backed fusible web is a fast and easy way to applique. Because fused patches are drawn on the paper side of the web and then flipped when ironed on the fabric, you may need to reverse the applique patterns (see specific pattern for instructions and whether reversing the presented patterns is necessary). Add  $\frac{3}{16}$ " underlap allowance to those edges that lie under another.

Trace the pattern pieces, also drawing the needed underlap allowances, on the paper side of a fusible web leaving at least  $\frac{1}{2}$ " between all the pieces. Cut about  $\frac{3}{16}$ " outside each drawn line.

To eliminate stiffness, try this variation for patches larger than 1": Cut out the center of the fusible web  $\frac{1}{4}$ " inside the drawn line, making a ring of fusible web.

Following the manufacturer's directions, iron the web, paper side up, to the wrong side of the fabric. Cut out the shape exactly on the drawn line. Carefully pull away the paper backing. Fuse the patches to the background where marked.

To finish the raw edges, satin stitch with stabilizer, or blanket stitch, zigzag or blind hem stitch using colored or invisible thread.

## Bias Strips

Bias strips are cut at a 45° angle to the grain of the fabric. They are stretchy and therefore ideal for creating curved applique stems.

Make your first cut by aligning a 45° guideline on your acrylic ruler with the cut edge or selvage of your fabric. Use this new bias edge to cut strips the required width.

Prepare bias strips for applique by folding in half lengthwise, wrong sides together. Stitch  $\frac{1}{4}$ " from the raw edges.

Offset the seam allowance; press toward the center. Trim the seam allowance to  $\frac{1}{8}$ ".

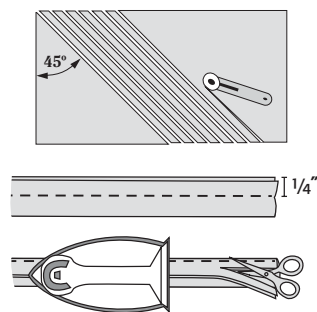

## pressing

Press all seam allowances to one side, usually toward the darker fabric; follow the pressing tabs presented with each pattern. When joining blocks and/or rows, seam allowances are pressed to allow nesting of seams which reduces bulk in the quilt top.

## techniques

### Curved Piecing

Cut patches using a small-bladed rotary cutter to maneuver curves.

With right sides together, pin the convex patch to the inside, or concave, curve of the second patch at the middle, the ends and a few places in between. Sew with the concave patch on the top, stopping frequently with the needle down to adjust the fabric to lay flat under the needle and presser foot. After stitching, press the seam allowance toward the convex piece.

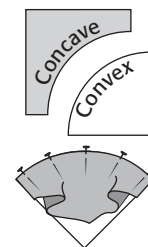

### Fast Flying Geese\*

Align 2 small squares on opposite corners of the large square, right sides together. Draw a diagonal line as shown and then stitch  $\frac{1}{4}$ " out from both sides of the line. Cut apart on the marked line.

With the small squares on top, open out the small squares and press the unit. On the remaining corner of each of these units, align a small square. Draw a line from corner to corner and sew  $\frac{1}{4}$ " out on both sides of the line. Cut on the marked lines, open the small squares and press.

Each set of 1 large square and 4 small squares makes 4 Flying Geese.

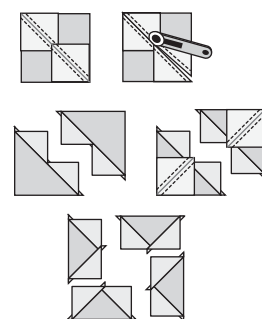

### Quarter-Square Triangles\*

With right sides together and the lighter fabric on top, pair one square of each color that makes the unit. On the lighter patch, draw a diagonal line from corner to corner.

Stitch  $\frac{1}{4}$ " out from both sides of the line. Cut apart on the marked line to make 2 triangle-squares. With the darker fabric up, open out the top patch and press the unit.

Cut both triangle-squares in half diagonally as shown. Referring to the diagram, join the appropriate halves to make 2 units.

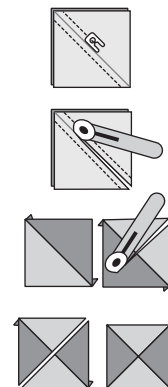

**\*These units will finish at the correct size for each pattern. No trimming is needed.**

## Set-in Seams

A **set-in patch** is inserted in an angle formed by two other patches. First, mark the seam lines on all three patches so you'll know exactly where to stitch. Align the edges of two patches and pin along the marked lines. Sew the seam, stopping the stitches at the end of the marked seam line; backstitch. Pivot the set-in patch so the adjacent edge aligns with the edge of the third patch. Matching seams, pin in place. Starting exactly where the previous seam ended, sew two stitches, then backstitch, taking care not to stitch into seam allowance. Stitch to the outer edge.

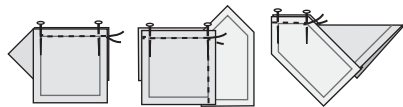

## Stitch-and-Flip

Align a patch (\* in this example) on a corner of a unit or second patch right sides together. Mark a diagonal line on the \* patch from corner to corner and sew on the marked line. Trim the seam allowance to 1/4" as shown. Flip the \* patch open and press.

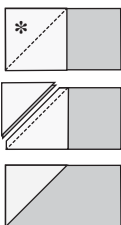

## Triangle-Squares\*

With right sides together and the lighter fabric on top, pair one square of each color that makes the unit. On the lighter patch, draw a diagonal line from corner to corner.

Stitch 1/4" out from both sides of the line.

Cut apart on the marked line.

With the darker fabric up, open out the top patch and press the unit.

A pair of squares will yield 2 units.

**\*These units will finish at the correct size for each pattern. No trimming is needed.**

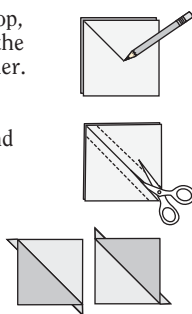

## Beading

Use a beading thread to secure beads to your work. It's advisable to make a knot after every bead or every few beads. Because bugle beads can be sharp and sometimes cut the thread, it helps to buffer them with a round bead at each end.



## Yo-yos

Using the circle diameter called for in the pattern (approximately twice the finished yo-yo size plus 1/2"), make a template. On the wrong side of the fabric, use the template to draw a circle. Cut out the circle on the marked line.

Turn under a scant 1/4" to the wrong side of the fabric. Sew a short basting stitch around the circle, leaving a knot and thread tail at the beginning of the circle.

Pull on the threads to gather the fabric, making sure the right side of the fabric is on the outside of the yo-yo. Take a few stitches to secure the gathering stitches and tie off. Clip the threads close to the knot.



## borders

**Squared borders** are added first to the sides of the quilt center, then to the top and bottom. Lay the quilt top flat on a large table or the floor. Lay both border #1 side strips down the vertical center of the quilt top and smooth carefully into place. Slip a small cutting mat under the quilt top (you'll need to do this at the top and the bottom) and use a rotary cutter and ruler to trim the border strips to the same length as the quilt top. Matching centers and ends, sew the border side strips to the quilt. Gently press the seam allowances away from the quilt center. For the top and bottom borders, repeat this process along the horizontal center of the quilt, including the newly added borders. Repeat for any remaining borders.



**Mitered borders** are added by sewing border strips to all sides of the quilt center and then mitering each corner. When joining each border strip to the quilt, begin and end stitches 1/4" from the quilt top corners and backstitch. Referring to the diagrams, fold the quilt right sides together diagonally at one corner. Flip the seam allowance toward the quilt top, match seam lines and pin through both layers about 3" from the corner. Place a ruler along the folded edge of the quilt top, intersecting the final stitch in the border seam and extending through the border strip. Draw a line from the stitch to the outer edge of the border. Pin together along the pencil line. Sew along the line to the edge of the border; backstitch. Trim seam allowances to 1/4"; press open. Repeat for all corners.

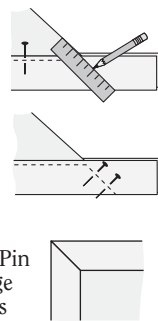

## marking

Trace the quilting motif on tracing paper. Place tracing paper under the quilt top with a light source behind. Lightly mark the design on the quilt top with a hard lead pencil or a marker of your choice. Test any marking product for removability before using it on your quilt.

Straight lines may be "marked" as you quilt by using masking tape that is pulled away after quilting along its edge.

## backing and basting

Make the quilt backing 4"-8" larger than the quilt top. Remove the selvages to avoid puckers. Usually 2 or 3 lengths must be sewn together; press the seam allowances open. Place the backing wrong side up on a flat surface, stretch slightly and tape or pin in place. Smooth the batting over the backing. Center quilt top right side up on top of the batting. Pin the layers as necessary to secure them while basting.

## Basting for Machine Quilting

Machine-quilted tops can be basted with rustproof safety pins. Begin at the center and place pins 3" to 4" apart, avoiding lines to be quilted.

## Basting for Hand Quilting

Beginning in the center of the quilt, baste horizontal and vertical lines 4" to 6" apart.

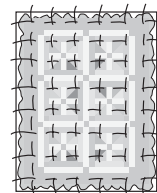

## quilting

**Quilt in the ditch** refers to quilting right next to the seam line on the side without seam allowances.

**Outline quilting** refers to quilting 1/4" from the seam line. **Echo quilting** refers to quilting one or more lines of stitching in uniform distances away from a patch.

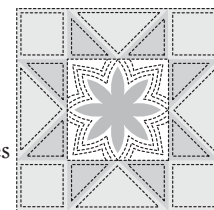

## Machine Quilting

Before machine quilting, bring the bobbin thread to the top of the quilt so it doesn't get caught as you quilt: lower the presser foot, hold the top thread and take one stitch down and up, lift the presser foot to release the thread tension and tug on the top thread to draw a loop of the bobbin thread to the top of the quilt. Pull the bobbin thread to the top. Lower the needle into the same hole created by the initial stitch, lower your presser foot, and start quilting. A walking foot is used for **straight-line** or **ditch** quilting. To **free-motion** quilt, drop (or cover) your feed dogs and use a darning foot. Start and end your quilting lines with 1/4" of very short stitches to secure.

## Hand Quilting

Hand quilting is done in a short running stitch with a single strand of thread that goes through all three layers.

Use a short needle (8 or 9 between) with about 18" of thread. Make a small knot in the thread, and take a long first stitch (about 1") through the top and batting only, coming up where the quilting will begin. Tug on the thread to pull the knotted end between the layers. Take short, even stitches that are the same size on the top and back of the quilt. Push the needle with a thimble on your middle finger; guide the fabric in front of the needle with the thumb of one hand above the quilt and with the middle finger of your other hand under the quilt.

To end a line of quilting, make a small knot in the thread close to the quilt top, push the needle through the top and batting only and bring it to the surface about 1" away; tug the thread until the knot pulls through the quilt top, burying the knot in the batting. Clip the thread close to the surface of the quilt.





## binding

Baste around the quilt  $\frac{3}{16}$ " from the edges. Trim the batting and backing  $\frac{1}{4}$ " beyond the edge of the quilt top.

To prepare the **binding strips**, place the ends of 2 binding strips perpendicular to each other, right sides together. Stitch diagonally and trim to  $\frac{1}{4}$ ". In this way, join all the strips and press the seam allowances *open*.

Cut the beginning of the binding strip at a  $45^\circ$  angle. Fold the binding strip in half along the length, wrong sides together, and press. Starting in the middle of a side and leaving a 6" tail of binding loose, align the raw edges of the binding with the edge of the quilt top. Begin sewing the binding to the quilt using a  $\frac{1}{4}$ " seam allowance. Stop  $\frac{1}{4}$ " from the first corner; backstitch. Remove the needle from the quilt and cut the threads.

Fold the binding up, then back down even with edge of the quilt. Begin stitching  $\frac{1}{4}$ " from the binding fold, backstitch to secure and continue sewing. Repeat at all corners.

When nearing the starting point, leave at least 12" of the quilt edge unbound and a 10" to 12" binding tail. Smooth the beginning tail over the ending tail. Following the cut edge of the beginning tail, draw a line on the ending tail at a  $45^\circ$  angle. To add seam allowance, draw a cutting line  $\frac{1}{2}$ " out from the first line; make sure it guides you to cut the binding tail  $\frac{1}{2}$ " longer than the first line. Cut on this second line.

To join the ends, place them right sides together. Offset the points so the strips match  $\frac{1}{4}$ " in from the edge and sew. Press the seam allowances open. Press the section of binding in half and then finish sewing it to the quilt. Trim away excess backing and batting *in the corners only* to eliminate bulk.

Fold the binding to the back of the quilt, enclosing the extra batting and backing. Blind-stitch the binding fold to the backing, just covering the previous line of stitching.

### Bias Binding

Bias binding strips are cut at a  $45^\circ$  angle to the grain of the fabric. They are stretchy and therefore ideal for binding curved edges.

Make your first cut by aligning a  $45^\circ$  guideline on your acrylic ruler with the cut edge or selvage of your fabric. Use this new bias edge to cut  $2\frac{1}{4}$ " strips for binding. Refer to "Binding" to finish the binding.

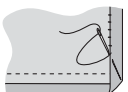
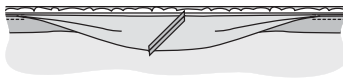
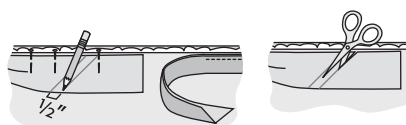
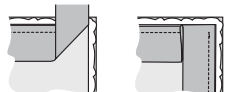
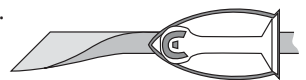
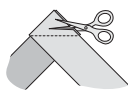
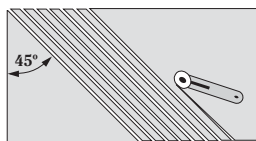

## facing

Trim the batting and backing even with the edges of the quilt top.

Cut the facing strips  $2\frac{1}{2}$ " wide and join end to end as you would binding.

For the top and bottom strips, measure across the quilt width. Cut 2 strips to this measurement minus  $\frac{1}{4}$ ". On both strips, fold one long edge under  $\frac{1}{4}$ " and press. On the right side of the quilt top, place one strip right side down at each end of the quilt, matching the ends of the strips to the sides of the quilt as shown. Pin.

Sew both of the strips to the quilt with  $\frac{1}{4}$ " seam allowance, beginning at one short end and turning the corner with one diagonal stitch as shown. Turn the second corner in the same way and finish sewing.

Lay the side facing strips right sides down on the quilt front sides. Trim the strips so the ends extend  $\frac{3}{4}$ " past the folded edge of the top and bottom strips. Fold one long edge under  $\frac{1}{4}$ " on both strips and press. Sew the side facing strips to the quilt with a  $\frac{1}{4}$ " seam allowance. Carefully trim the bulk from each corner.

To make the facing lie flat, sew a line of sharpstitching: first, fold the side facing strip out as shown. Beginning about  $2\frac{1}{2}$ " from the corner, sew through all the seam allowances and the facing very close to the seam, ending  $2\frac{1}{2}$ " from the next corner. Repeat for all the sides. Turn the facing to the back of the quilt and gently push out the corners. Press the facing flat. Sew the facing to the quilt back by hand with a blind stitch.

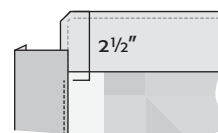
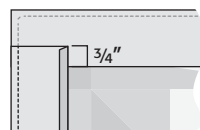
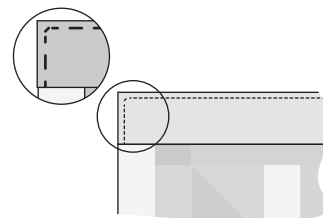

### sleeve for hanging

Sleeve edges can be caught in the seam when you sew the binding to the quilt. Cut and join enough 9"-wide strips of fabric to equal the width of the quilt. Hem the short ends of the sleeve by folding under  $\frac{1}{2}$ ", pressing, then folding and pressing once more; topstitch close to the edge of the hem. Fold the sleeve in half lengthwise, wrong sides together, matching raw edges. Center the sleeve on the back and top of the quilt and baste. Sew the binding to the quilt. Once the binding has been sewn, smooth the sleeve against the backing and blindstitch along the bottom and along the ends of the sleeve, catching some of the batting in the stitches. ■

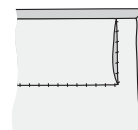

Quiltmaker  
The Quilts You Want to Make—We Show You How

Copyright © 2016 F+W, a content + ecommerce company  
All rights reserved. [quiltmaker.com](http://quiltmaker.com)

Quiltmaker is glad to grant permission for you to display your quilt in quilt shows and to use *Quiltmaker* patterns for charity quilts. Please include credits in the following format: "Pattern Name, designed by Designer Name. Pattern appears in *Quiltmaker* Month/Month Year. [quiltmaker.com](http://quiltmaker.com)."